

# ANTI-SQUAT TUNING / ANTI-SQUAT EINSTELLUNG / RÉGLAGE DE L'ANTI-CABRAGE / MESSA A PUNTO ANTI-SQUAT

	<b>EN</b> Low Roll Center (LRC) <b>DE</b> Niedrige Rollmitte (LRC) <b>FR</b> LRC centre de roulis bas <b>IT</b> Centro rollio basso (LRC)	<b>EN</b> High Roll Center (HRC) – <i>Optional</i> <b>DE</b> Hohe Rollmitte (HRC) – <i>Optional</i> <b>FR</b> HRC Centre de roulis haut – <i>en option</i> <b>IT</b> Centro rollio alto (HRC) – <i>Opzionale</i>
	+	+
1.0 degree 1,0° 1 Degré 1.0 grado		
2.0 degree 2,0° 2 Degrés 2.0 grado		
2.5 degree 2,5° 2.5 Degrés 2.5 grado		
3.0 degree 3,0° 3 Degrés 3.0 grado		

# BELT TENSION / RIEMENSPIANNUNG / TENSION DES COURROIES / TENSIONE CINGHIA

EN

## 22-4 Rear Belt Tension

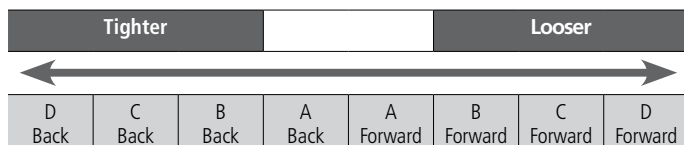

## 22-4 Side Belt Tension

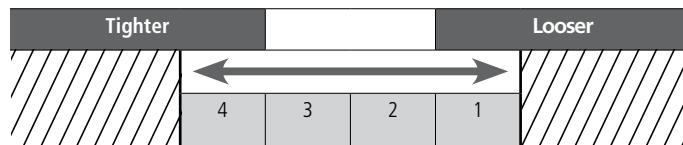

## Overall Rear Belt Tension

Reference Number	1	2	3	4	5	6	7	8	9	10	11	12	13	14	15	16w
Rear Belt Tension	D Back	C Back	B Back	A Back	A Forward	B Forward	C Forward	D Forward	D Back	C Back	B Back	A Back	A Forward	B Forward	C Forward	D Forward
Side Belt Tension	1								2							
	← Tightest				← Even Tighter				← Tighter				← Tight			
Reference Number	17	18	19	20	21	22	23	24	25	26	27	28	29	30	31	32
Rear Belt Tension	D Back	C Back	B Back	A Back	A Forward	B Forward	C Forward	D Forward	D Back	C Back	B Back	A Back	A Forward	B Forward	C Forward	D Forward
Side Belt Tension	3								4							
	Loose →				Looser →				Even Looser →				Loosest →			

DE

## Spannung hinterer Riemen

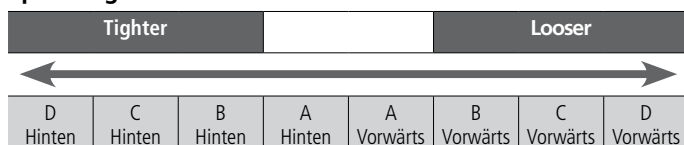

## Spannung seitlicher Riemen

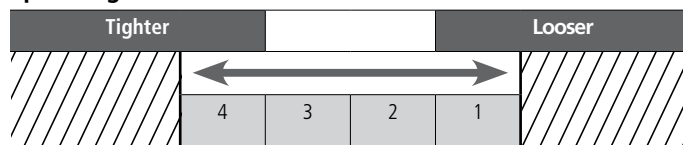

## Spannung Hauptriemen

Referenz Nummer	1	2	3	4	5	6	7	8	9	10	11	12	13	14	15	16w
Spannung hinterer Antriebsriemen	D Hinten	C Hinten	B Hinten	A Hinten	A Vorwärts	B Vorwärts	C Vorwärts	D Vorwärts	D Hinten	C Hinten	B Hinten	A Hinten	A Vorwärts	B Vorwärts	C Vorwärts	D Vorwärts
Spannung seitlicher Riemen	1								2							
	← Ganz stramm				← Etwas strammer				← Stramm				← Wenig stramm			
Referenz Nummer	17	18	19	20	21	22	23	24	25	26	27	28	29	30	31	32
Spannung hinterer Antriebsriemen	D Hinten	C Hinten	B Hinten	A Hinten	A Vorwärts	B Vorwärts	C Vorwärts	D Vorwärts	D Hinten	C Hinten	B Hinten	A Hinten	A Vorwärts	B Vorwärts	C Vorwärts	D Vorwärts
Spannung seitlicher Riemen	3								4							
	Locker →				Noch lockerer →				Noch weiter lockerer →				Ganz locker →			

## 22-4 Tension de la courroie arrière

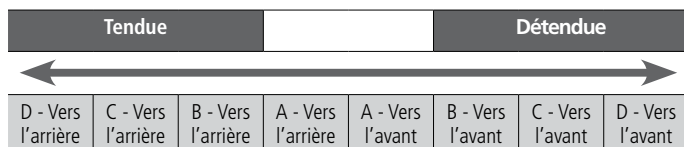

## 22-4 Tension de la courroie latérale

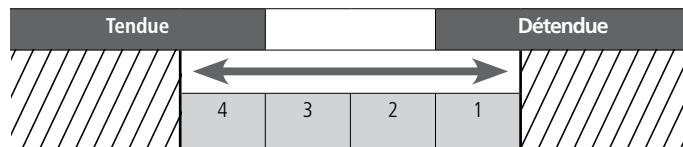

## Tension globale de la courroie arrière

Numéro de référence	1	2	3	4	5	6	7	8	9	10	11	12	13	14	15	16w
Tension de la courroie arrière	D - Vers l'arrière	C - Vers l'arrière	B - Vers l'arrière	A - Vers l'arrière	A - Vers l'avant	B - Vers l'avant	C - Vers l'avant	D - Vers l'avant	D - Vers l'arrière	C - Vers l'arrière	B - Vers l'arrière	A - Vers l'arrière	A - Vers l'avant	B - Vers l'avant	C - Vers l'avant	D - Vers l'avant
Tension de la courroie latérale	1								2							
	← Le plus tendu				← Encore plus tendu				← Plus tendu				← Tendu			
Numéro de référence	17	18	19	20	21	22	23	24	25	26	27	28	29	30	31	32
Tension de la courroie arrière	D - Vers l'arrière	C - tVers l'arrière	B - Vers l'arrière	A - Vers l'arrière	A - Vers l'avant	B - Vers l'avant	C - Vers l'avant	D - Vers l'avant	D - Vers l'arrière	C - Vers l'arrière	B - Vers l'arrière	A - Vers l'arrière	A - Vers l'avant	B - Vers l'avant	C - Vers l'avant	D - Vers l'avant
Tension de la courroie latérale	3								4							
	Détendu →				Plus détendu →				Encore plus détendu →				Le plus détendu →			

## 22-4 Tensione cinghia posteriore

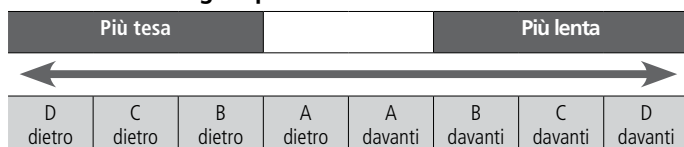

## 22-4 Tensione cinghia laterale

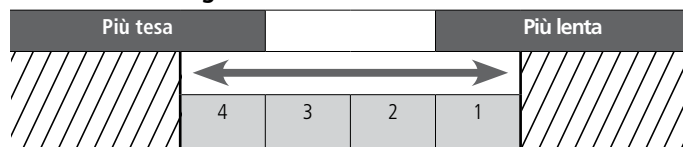

## Tensione complessiva cinghia posteriore

Numero di riferimento	1	2	3	4	5	6	7	8	9	10	11	12	13	14	15	16w
Tensione cinghia posteriore	D dietro	C dietro	B dietro	A dietro	A davanti	B davanti	C davanti	D davanti	D dietro	C dietro	B dietro	A dietro	A davanti	B davanti	C davanti	D davanti
Tensione cinghia laterale	1								2							
	← Tesissima				← Ancora più tesa				← Più tesa				← Tesa			
Numero di riferimento	17	18	19	20	21	22	23	24	25	26	27	28	29	30	31	32
Tensione cinghia posteriore	D dietro	C dietro	B dietro	A dietro	A davanti	B davanti	C davanti	D davanti	D dietro	C dietro	B dietro	A dietro	A davanti	B davanti	C davanti	D davanti
Tensione cinghia laterale	3								4							
	Lenta →				Più lenta →				Ancora più lenta →				Lentissima →			

REPLACEMENT PARTS / ERSATZTEILE / PIÈCES DE RECHANGE / PEZZI DI RICAMBIO

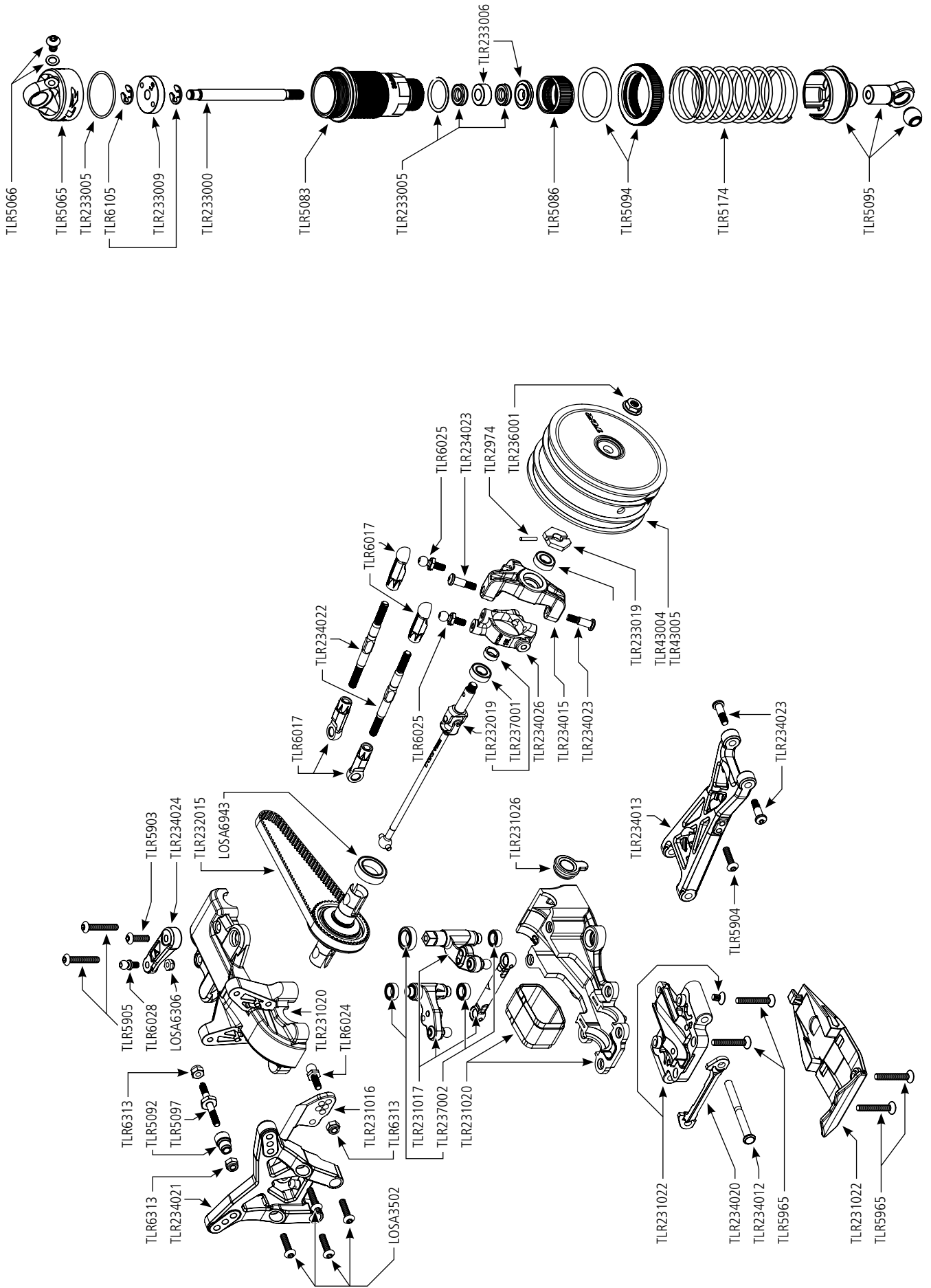

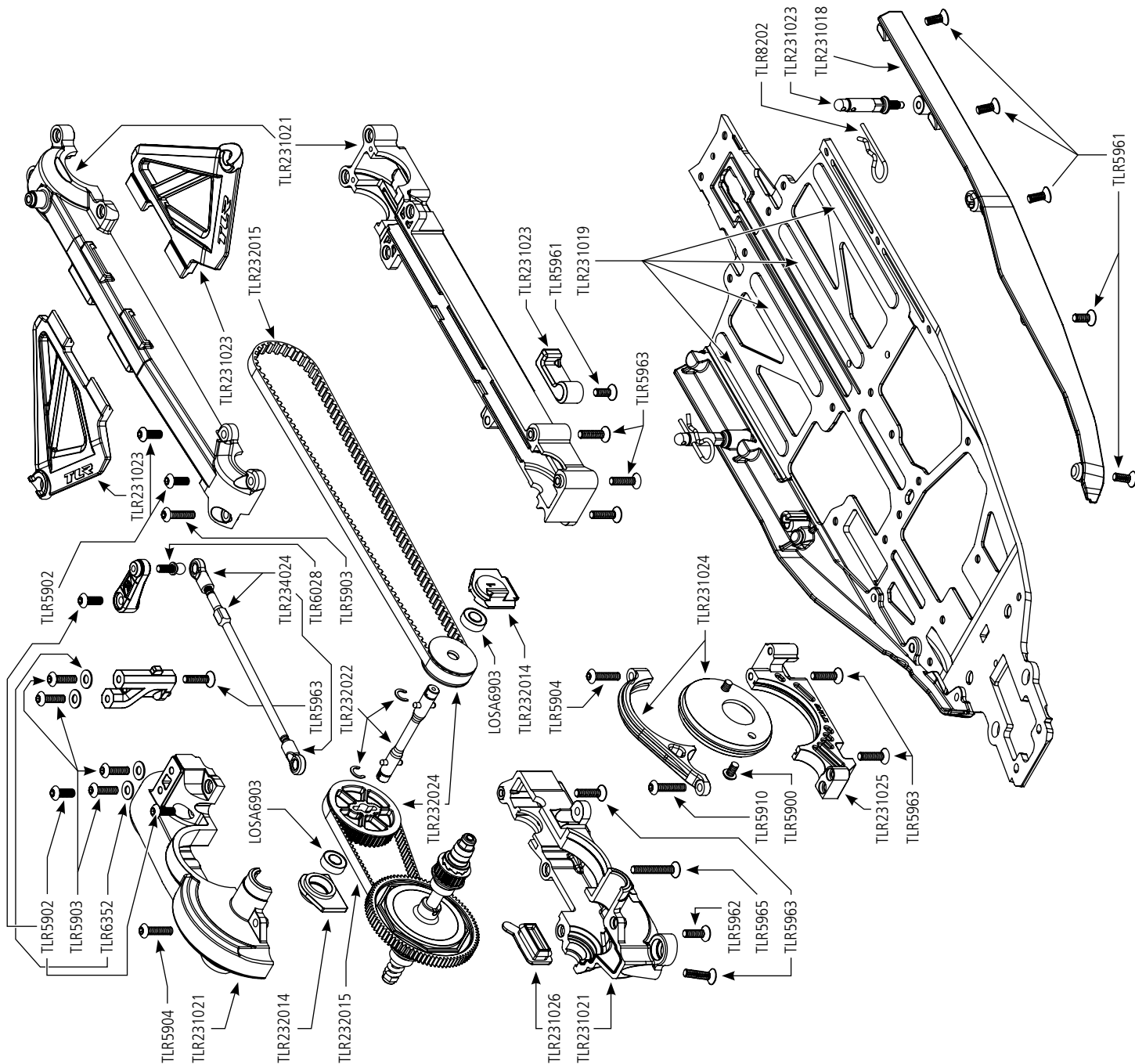



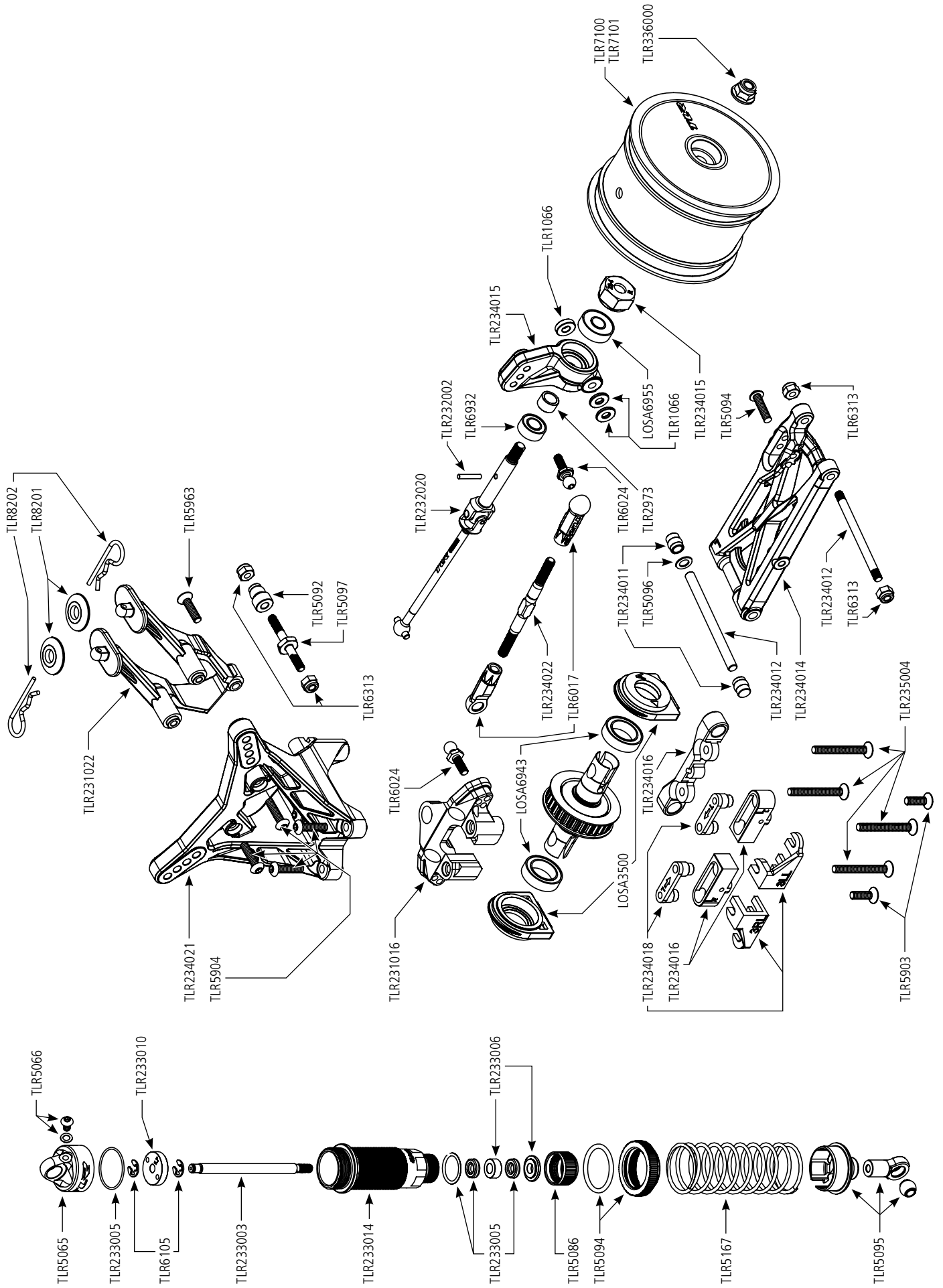

Part #	English	Deutsch	Français	Italiano
LOSA4002	Antenna Kit	Losi Antennen Kit	Tube d'antenne	Kit antenna
LOSA6306	4-40 Aluminum Mini-Nuts (10)	Losi 4-40 Aluminium Mini-Muttern (10)	Mini écrous 4-40 (10)	4-40 Mini dadi alluminio (10)
LOSA6916	3/16" x 3/8" Ball Bearings (2)	3/16 x 3/8 Kugellager (2)	Roulements 3/16"x 3/8" (2)	3/16" x 3/8" Cuscinetti a sfere (2)
LOSA6943	10 x 15mm Sealed Ball Bearing (2): 22	Losi 10 X 15mm Kugellager gekapselt (2): 22	Roulements étanches 10x15mm (2)	10 x 15mm Cuscinetti stagni (2): 22
LOSA6955	5 x 13mm HD Clutch Bearings (2): 8B/8T	Losi 5 x 13mm HD Kupplungslager (2):8B/8T	Roulements renforcés 5x13mm	5 x 13mm HD Cuscinetti frizione (2): 8B/8T
TLR230004	Body & Wing Set: 22-4	Karosserie u. Flügelset: 22-4	Carrosserie et aileron	Set carrozzeria e alettone: 22-4
TLR231016	Camber Block Set, Aluminum: 22-4	Camber Block Set Aluminium: 22-4	Set de cales de carrossage en aluminium	Set blocco camber, alluminio: 22-4
TLR231017	Steering Bellcrank Set: 22-4	Lenkhebel Set: 22-4	Renvois de direction	Set quadrette sterzo: 22-4
TLR231018	Mud Guard Set: 22-4	Schmutzfänger: 22-4	Bavettes	Set parafango: 22-4
TLR231019	Chassis: 22-4	Chassis: 22-4	Châssis	Telaio: 22-4
TLR231020	Front Belt Cover & Sub Frame: 22-4	Riemenabdeckung vorne: 22-4	Carter avant de protection de courroie	Copertura cinghia anteriore & sotto telaio : 22-4
TLR231021	Belt Cover Set, Center & Rear: 22-4	Riemenabdeckung mitte und hinten: 22-4	Couvercle de protection central et avant	Set copertura cinghia, centrale & posteriore: 22-4
TLR231022	Front Pivot, Bumper & Wing Stay: 22-4	Stoßfänger vorne u. Flügelhalter: 22-4	Cellule, pare-choc avant et support d'aileron	Perno anteriore, supporto paraurti e alettone: 22-4
TLR231023	Battery Mount Set: 22-4	Akkuhalter: 22-4	Support de batterie	Set supporto batteria: 22-4
TLR231024	Motor Cam & Strap, Aluminum: 22-4	Motorhalter Alu: 22-4	Came et pontet de fixation moteur en aluminium	Camme motore & laccio, alluminio: 22-4
TLR231025	Motor Mount, Aluminum: 22-4	Motorträger: 22-4	Support moteur en aluminium	Supporto motore, alluminio: 22-4
TLR231026	Access Plugs: 22-4	Zugangsstecker: 22-4	Capuchons	Connettori accesso: 22-4
TLR232002	Solid Drive Pin Set (8): 22/T/SCT	TLR Antriebspin Set (8): 22/T/SCT	Jeu de goupilles d'entraînement pleines (8)	Set perni trasmissione (8): 22/T/SCT
TLR232007	HDS Slipper Pad (2)	TLR HDS Slipper Pad (2)	Garniture de slipper HDS (2)	HDS Pattino antisaltellamento (2)
TLR232012	HDS Spur Gear, 84T 48P, Kevlar: ALL 22	HDS Zahnrad, 84T 48P, Kevlar: alle 22	Couronne HDS 84T 48p en kevlar	HDS corona, 84T 48P, Kevlar: ALL 22
TLR232014	Drive Belt Adjustment Inserts: 22-4	Antriebsriemeneinsätze: 22-4	Inserts de réglage de tension des courroies	Inserti regolazione cinghia trasmissione: 22-4
TLR232015	Drive Belt Set: 22-4	Antriebsriemen: 22-4	Set de courroies	Set cinghia trasmissione: 22-4
TLR232016	Thrust Bearing Set, Slipper: 22-4	Drucklager Kupplung: 22-4	Butée à bille et accessoires de slipper	Set cuscinetto reggispinta, slipper: 22-4
TLR232017	Outdrive Set: 22-4	Abtriebs-Set: 22-4	Noix de sortie de différentiel	Set trascinateur: 22-4
TLR232018	Diff Rings (4): 22-4	Diff-Ringe (4): 22-4	Plateaux de différentiel (4)	Anelli differenziale (4): 22-4
TLR232019	Front Driveshaft Assembly (2): 22-4	Antriebswelle vorne (2): 22-4	Cardan avant complet (2)	Gruppo albero anteriore (2): 22-4
TLR232020	Rear Driveshaft Assembly (2): 22-4	Antriebswelle hinten (2):22-4	Cardan arrière complet (2)	Gruppo albero posteriore (2): 22-4
TLR232021	Slipper Plate Set: 22-4	Rutschkupplung Platten Set: 22-4	Set de plateaux du slipper	Set piastra slipper: 22-4
TLR232022	Slipper & Jackshaft Assembly: 22-4	Rutschkupplung Zwischenwelle: 22-4	Axe intermédiaire et de slipper	Gruppo slipper e albero secondario: 22-4
TLR232023	One-Way/Clicker Set: 22-4	Freilauf Set: 22-4	Roue libre	Set ruota libera/clicker: 22-4
TLR232024	Drive & Differential Pulley Set: 22-4	Antriebs u. Diff- Wellen Set: 22-4	Set de poulies de différentiel et de transmission	Set pulegge trasmissione e differenziale: 22-4
TLR233000	Shock Shaft, 3.5 x 44mm, Ti-CN (2)	TLR Kolbenstange 3.5 x 44mm Ti-CN (2)	Tiges d'amortisseurs, 3.5 x 44mm, Ti-CN (2)	Albero ammortizzatore, 3.5 x 44mm, Ti-CN (2)



Part #	English	Deutsch	Français	Italiano
TLR233003	Shock Shaft, 3.5 x 52mm, Ti-CN (2)	Stoßdämpferkolbenstange 3.5 x 52mm, Ti-CN (2)	Tiges d'amortisseur Ti-CN, 3.5 x 52mm (2)	Alberino ammort., 3.5 x 52mm, Ti-CN (2)
TLR233005	Seal Set, X-Rings, Shock Cap O-Rings: All 22	TLR Dichtungssset X Ringe Stoßdämpferkappen O-ringe: alle 22	Set de joints d'étanchéité et toriques de bouchons d'amortisseurs	Set guarnizioni, x-ring, o-ring tappo ammortizzatore: All 22
TLR233006	Shock Bushing Set, Machined (4): All 22	TLR Stoßdämpferlager Set (4) alle 22	Set de paliers d'amortisseurs usinés (4)	Set boccole ammortizzatore, fresate (4): tutti 22
TLR233009	Shock Piston 12mm 1.6 x 2 CNC Machined(4): All22,SCTE	TLR Stoßdämpferkolben 12mm 1.6 x 2 CNC (4) alle 22, SCTE	Pistons d'amortisseurs usinés CNC diamètre 12mm, 1,6 x 2 trous (4)	Pistone ammortizzatore 12mm 1.6 x 2 prodotto con CNC (4): All 22,SCTE
TLR233010	Shock Piston 12mm 1.7 x 2 CNC Machined (4): All22, SCTE	Stoßdämpferkolben 12mm 1.7 x 2 CNC gedreht (4): alle 22, SCTE	Piston d'amortisseur diam 12mm usine CNC, 1.7 x 2 (4)	Pistone ammort. 12mm 1.7 x 2 fresato CNC (4): All22, SCTE
TLR233014	Rear Shock Body Set (2): 22-4	Stoßdämpfergehäuse Set (2) 22-4	Corps d'amortisseur arrière (2)	Set corpo ammort. posteriore (2): 22-4
TLR234011	Suspension Pivot Ball, Molded: All 22	TLR Querlenkerhalter Kugelköpfe alle 22	Boules de pivots de suspensions	Sfera perno sospensione, stampata: All 22
TLR234012	Hinge Pin Set, Ti-CN (6):22-4	Hinge Pin Set, Ti-CN (6): 22-4	Axes de suspension Ti-Cn (6)	Set perni cerniere, Ti-CN (6):22-4
TLR234013	Front Arm Set: 22-4	Querlenker vorne Set: 22-4	Triangles avant	Set bracci anteriori: 22-4
TLR234014	Rear Arm Set: 22-4	Querlenker hinten Set: 22-4	Triangles arrière	Set bracci posteriori: 22-4
TLR234015	Front Spindle & Rear Hub Set : 22-4	Front Spindel & hintere Radträger: 22-4	Set de fusées avant et arrière	Set fuso anteriore e mozzo posteriore: 22-4
TLR234016	Pivot Set, Rear, LRC: 22-4	Pivot Set hinten, LRC: 22-4	Set de cales de pincement arrière LRC	Set perno posteriore, LRC: 22-4
TLR234018	Anti-Squat Tuning Set, LRC: 22-4	Anti-Squat Tuning Set, LRC: 22-4	Cales de réglage d'anti-cabrage	Set messa a punto anti-squat, LRC: 22-4
TLR234020	Front Pivot Brace, Aluminum: 22-4	Chassishalter vorne: 22-4	Renfort de cellule avant en aluminium	Supporto perno anteriore, alluminio: 22-4
TLR234021	Shock Tower Set: 22-4	Stoßdämpferbrücken-Set: 22-4	Set de supports d'amortisseurs	Set torre ammortizzatore: 22-4
TLR234022	Turnbuckle Set: 22-4	Gewindestangen: 22-4	Set de biellettes	Set tenditore: 22-4
TLR234023	King Pin Screws (8): 22-4	King Pin Schrauben (8): 22-4	Pivots de fusées (8)	Viti perni king (8): 22-4
TLR234024	Servo & Steering Horn Set: 22-4	Servo und Lenkhorn Set: 22-4	Bras de servo et bras de direction	Set squadrette servi e sterzo: 22-4
TLR234026	Castor Block Set, 15 degrees, Aluminum: 22-4	C.Hub 15° Alu: 22-4	Etriers porte fusée 15° en aluminium	Set blocco Castor, 15 gradi, alluminio: 22-4
TLR234028	Ball Stud, 4.8mm x 5mm (4)	Kugelköpfe 4.8 x 5mm (4)	Rotule 4.8 x 5mm	Attacchi a sfera, 4.8mm x 5mm (4)
TLR235003	Flat Head Screws, M2.5 x 6mm (10)	Flachkopfschrauben, M2,5 x 6mm (10)	Vis FHC M2.5 x 6mm	Viti a testa piatta, M2.5 x 6mm (10)
TLR235004	Flat Head Screws, M3 x 25mm (10)	Flachkopfschrauben, M3 x 25mm (10)	Vis FHC M3 x 25mm	Viti a testa piatta, M3 x 25mm (10)
TLR236001	4mm Low Profile Serrated Nuts (4)	TLR: Flache Riffelschrauben 4mm (4)	Ecrous striés M4 taille basse (4)	Dadi dentellati a basso profilo 4mm (4)
TLR237000	5 x 8 x 2.5mm Bearings (2)	TLR 5 x 8 x 2.5mm Lager (2)	Roulements 5 x 8 x 2.5mm	5 x 8 x 2.5mm cuscinetti (2)
TLR237001	5 x 10 x 3mm Bearings (2)	TLR 5 x 10 x 3mm Lager (2)	Roulements 5 x 10 x 3mm	5 x 10 x 3mm cuscinetti (2)
TLR237002	Steering Bearing Set (4): 22-4	Kugelkopf Lenkung (4): 22-4	Roulements de direction (4)	Set cuscinetti sterzo (4): 22-4
TLR2946	Diff Nut, GenII, 22/T/SCT	TLR Spannmutter Diff Gen 22/T/SCT	Ecrou de diff gen II	Dado diff., GenII, 22/T/SCT
TLR2947	Tungsten Carbide Diff Balls, 2mm (6)	TLR Tungsten Carbide Kugeln, 2mm (6)	Billes de différentiel en carbure de tungstène, 2mm (6)	Sfere diff. al carburo di tungsteno, 2mm (6)
TLR2951	Tungsten Carbide Diff Balls, 3/32mm (14) 22/T/SCT	TLR Tungsten Carbide Kugel 3/32 (14)	Bille de différentiel en carbure de tungstène, 3/32 (14)	Sfere diff. al carburo di tungsteno, 3/32mm (14) 22/T/SCT
TLR2952	Silicone Diff Grease, 8cc: 22	TLR Differentialfett/8cc: 22	Graisse silicone pour diff, 8cc	Grasso silicone diff., 8cc: 22
TLR2958	Diff Through Screw & Nut: 22	TLR Spannschraube mit Mutter: 22	Vis et écrou de serrage du diff	Viti passanti diff. & dadi: 22
TLR2959	Diff Spring: 22	TLR Druckfeder Diff: 22	Ressort de diff	Molla diff.: 22

Part #	English	Deutsch	Français	Italiano
TLR336000	4mm Aluminum Serrated Lock Nuts, Black (6)	TLR 4mm Aluminium Stopmutter mit Flanch Schwarz 6St.	Ecrou auto-freiné épaulé M4, aluminium, noir (6)	Dado autobloccante seghettato 4mm, nero (6)
TLR43004	Front Wheel, Yellow (2): 22-4	Vorderad Gelb (2)	Jante avant jaune (2)	Ruota anteriore, gialla (2): 22-4
TLR43005	Front Wheel, White (2): 22-4	Vorderad Weiss (2)	Jante arrière blanche (2)	Ruota anteriore, bianca (2): 22-4
TLR5065	Bleeder Shock Caps, Alum (2): 22/T	TLR Stoßdämpferkappen Set (2): 22/T	Bouchons d'amortisseurs en aluminium avec purgeurs (2)	Tappo sfiato ammortizzatori, allum. (2): 22/T
TLR5066	Bleeder Shock Cap Screw & Washers (4): 22/T	Stoßdämpfervolumenausgleichkappe, Schraube und Unterlegscheibe (4) 22/T	Vis de purge avec joints (4)	Vite e rondelle tappo sfiato ammortizzatore. (4): 22/T
TLR5077	Shock Tool Kit, 12mm Shock	TLR Dämpfer-Werkzeugsatz, 12mm Dämpfer	Outil pour amortisseur 12mm	Kit attrezzi ammortizzatore, 12mm
TLR5083	Front Shock Body Set (2): 22	TLR Dämpfergehäuse-Set Vorne (2): 22	Set de corps d'amortisseurs avant (2)	Set corpo ammortizzatore anter. (2): 22
TLR5086	Shock Cap: Bottom (2): 22	TLR Stoßdämpferendkappe unten (2):22	Bouchon inférieur d'amortisseur (2)	Tappo ammort.: inferiore (2): 22
TLR5092	Upper Shock Bushing (4): 22	TLR Buchsen für Dämpfer: 22 (4)	Entretoise supérieure d'amortisseur (4)	Boccola superiore ammort. (4): 22
TLR5094	Shock Preload Adjuster Nut w/O-ring: 22	TLR Stoßdämpfer Rändelmutter m. O-Ring	Bague de réglage d'amortisseur avec joint torique	Dado regolazione precarico ammort. senza O-ring: 22
TLR5095	Shock End Set w/Spring Cups, 12mm Shock: 22	TLR Endkugelpfanne / Federteller, 12mm Dämpfer: 22	Chapes et coupelles d'amortisseurs	Terminale ammort. c/molla a tazza, 12mm: 22
TLR5097	Shock Standoff (2): 22	TLR Dämpferhalter: 22	Entretoise d'amortisseur (2)	Supporto ammortizzatore (2): 22
TLR5900	Button Head Screws, M3 x 5mm (10)	TLR Rundkopfschraube, M3 x 5mm (10)	Vis à tête bombée M3 x 5mm (10)	Viti testa tonda, M3 x 5mm (10)
TLR5901	Button Head Screws, M3 x 6mm (10)	TLR Rundkopfschraube, M3 x 6mm (10)	Vis à tête bombée M3 x 6mm (10)	Viti testa tonda, M3 x 6mm (10)
TLR5902	Button Head Screws, M3 x 8mm (10)	TLR Rundkopfschraube, M3 x 8mm (10)	Vis à tête bombée M3 x 8mm (10)	Viti testa tonda, M3 x 8mm (10)
TLR5905	Button Head Screws, M3 x 18mm (10)	TLR Rundkopfschraube, M3 x 18mm (10)	Vis à tête bombée M3 x 18mm (10)	Viti testa tonda, M3 x 18mm (10)
TLR5910	Button Head Screws, M3 x 14mm (10)	TLR Rundkopfschraube, M3 x 14mm (10)	Vis à tête bombée M3 x 14mm (10)	Viti testa tonda, M3 x 14mm (10)
TLR5958	Flat Head Screw, M2 x 8mm (10)	TLR Flachkopfschrauben, M2 x 8mm (10)	Vis à tête fraisée M2 x 8mm (10)	Vite a testa piatta, M2 x 8mm (10)
TLR5962	Flat Head Screw, M3 x 10mm (10)	TLR Flachkopfschrauben, M3 x 10mm (10)	Vis à tête fraisée M3 x 10mm (10)	Vite a testa piatta, M3 x 10mm (10)
TLR5963	Flat Head Screw, M3 x 12mm (10)	TLR Flachkopfschrauben, M3 x 12mm (10)	Vis à tête fraisée M3 x 12mm (10)	Vite a testa piatta, M3 x 12mm (10)
TLR5965	Flat Head Screw, M3 x 20mm (10)	TLR Flachkopfschrauben, M3 x 20mm (10)	Vis à tête fraisée M3 x 20mm (10)	Vite a testa piatta, M3 x 20mm (10)
TLR6017	Rod End, 4mm Turnbuckle (12): 22SCT	Kugelpfannen Hinten (12): 22SCT	Chape rotule 4mm (12)	Terminale barra, tenditore 4mm (12): 22SCT
TLR6024	Ball Stud, 4.8 x 8mm (4): 22	TLR Kugelkopf mit Gewinde, 4.8 x 8mm (4): 22	Rotules à visser 4,8mm x 8mm (4)	Perno sferico, 4.8 x 8mm (4): 22
TLR6025	Ball Stud, 4.8 x 6mm (4): 22	TLR Kugelkopf mit Gewinde 4.8mm x 6mm (4): 22	Rotules à visser 4,8mm x 6mm (4)	Perno sferico, 4.8 x 6mm (4): 22
TLR6028	Ball Stud, Short Neck, 5mm (2)	TLR Kugelkopf mit Gewinde kurzen Hals, 5mm (2)	Rotules à visser courtes 5mm (2)	Perno sferico, Short Neck, 5mm (2)
TLR6105	E-Clips, 3mm Shaft (12)	TLR E-Clipse, 3mm (12)	Clips pour arbre 3mm (12)	E-Clips, 3mm Shaft (12)
TLR6313	Locknut, M3 x .5 x 5.5mm (10)	TLR Mutter selbstsichernd M3 x .5 x 5.5mm (10)	Ecrou M3 x 0,5 x 5,5mm (10)	Dado autobloccante, M3 x .5 x 5.5mm (10)
TLR6932	5x10x4mm HD Bearings (2)	TLR Kugellager 5 x 10 x 4mm (2)	Roulements renforcés 5x10x4mm (2)	5x10x4mm HD Cuscinetti (2)
TLR7100	Rear Wheel, White (2): 22	TLR Felge hinten, Weiss (2): 22	Jante arrière blanc (2)	Ruota posteriore, bianca (2): 22
TLR7101	Rear Wheel, Yellow (2): 22	TLR Felge hinten, Gelb (2): 22	Jante arrière jaune (2)	Ruota posteriore, gialla (2): 22
TLR76004	TLR Lok, Threadlock, Blue	TLR Schraubensicherungslack Blau	Frein filet TLR Lok, bleu	TLR Lok, frenafilet, blu

Part #	English	Deutsch	Français	Italiano
TLR77000	High-Pressure Black Grease, 8cc	TLR High-Pressure Fett Schwarz/8cc	Graisse noire haute pression, 8cc	Grasso nero alta pressione, 8cc
TLR8201	Wing Washers (4): 22	TLR U-Scheibe Spoiler (4): 22	Rondelles d'aïlèron	Rondelle alettone (4): 22
TLR8202	Body Clips, Black (12): 22	TLR Karosseriekammern Schwarz (12): 22	Clips de carrosserie (12), noirs	Clips carrozzeria, neri (12): 22

## OPTIONAL PARTS / DIVERSE TEILE / PIÈCES OPTIONNELLES / PARTI OPZIONALI

Part #	English	Deutsch	Français	Italiano
TLR232009	HDS Spur Gear, 76T 48P, Kevlar: All 22	TLR HDS Zahnrad 76T 48P Kevlar: alle 22	Couronne Kevlar HDS, 76T 48P	Corona HDS, 76T 48P, Kevlar: All 22
TLR232010	HDS Spur Gear, 78T 48P, Kevlar: ALL 22	TLR HDS Zahnrad 78T 48P Kevlar: alle 22	Couronne Kevlar HDS, 78T 48P	Corona HDS, 78T 48P, Kevlar: All 22
TLR232011	HDS Spur Gear, 82T 48P, Kevlar: All 22	TLR HDS Zahnrad 82T 48P Kevlar: alle 22	Couronne Kevlar HDS, 82T 48P	Corona HDS, 82T 48P, Kevlar: All 22
TLR232013	HDS Spur Gear, 86T 48P, Kevlar: All 22	TLR HDS Zahnrad 86T 48P Kevlar: alle 22	Couronne Kevlar HDS, 86T 48P	Corona HDS, 86T 48P, Kevlar: All 22
TLR232026	Diff Service Kit, Tungsten Balls: 22-4	Diff Wartungsset: 22-4	Kit de réparation de différentiel, billes tungstène	Kit manutenzione diff., sfere in tungsteno: 22-4
TLR233007	Shock Piston 12mm 1.3 x 2 CNC Machined(4):All22,SCTE	Stoßdämpferkolben 12mm 1.3 x 2 CNC gefertigt (4) Alle 22, SCTE	Piston d'amortisseur usiné CNC, 1.3 x 2 diam 12mm (4)	Pistoni ammort. 12mm 1.3 x 2 fresati CNC (4):All22,SCTE
TLR233008	Shock Piston 12mm 1.5x2 CNC Machined(4): All22,SCTE	TLR Stoßdämpferkolben 12mm 1.5 x 2 CNC gefertigt (4) Alle 22, SCTE	Pistons d'amortisseurs usinés CNC diamètre 12mm, 1,5 x 2 trous (4)	Pistone ammortizzatore 12mm 1.5 x 2 fresato (4): All 22,SCTE
TLR233011	Shock Piston 12mm Blank CNC Machined(4): All22,SCTE	TLR Stoßdämpferkolben 12mm CNC gefertigt (4) Alle 22, SCTE	Pistons d'amortisseurs usinés CNC diamètre 12mm, à percer (4)	Pistone ammortizzatore 12mm Blank fresato (4): All 22,SCTE
TLR234017	Pivot Set, Rear, HRC: 22-4	Pivot Set hinten, HRC: 22-4	Set de cales de pincement arrière HRC	Set perno, posteriore, HRC: 22-4
TLR234019	Anti-Squat Tuning Set, HRC: 22-4	Anti-Squat Tuning Set, HRC: 22-4	Set de cales de réglage d'anti-cabrage HRC	Set messa a punto anti-squat, HRC: 22-4
TLR234025	Castor Block Set, 10 degrees, Aluminium: 22-4	C.Hub 10° Alu: 22-4	Set d'étriers porte fusées 10° en aluminium	Set blocco castor, 10 gradi, alluminio: 22-4
TLR234027	Castor Block Set, 20 degrees, Aluminium: 22-4	C.Hub 20° Alu: 22-4	Set d'étriers porte fusées 20° en aluminium	Set blocco castor, 20 gradi, alluminio: 22-4
TLR238000	Support Kit: 22-4	TLR Support Kit: 22-4	Kit de réparation	Kit supporto: 22-4
TLR2950	Hex Differential Wrench, Aluminium: 22	TLR Diff Einstellschlüssel, Aluminium: 22	Clé hexagonale pour différentiel	Chiave esagonale differenziale, alluminio: 22
TLR331004	TLR 22-4 Chassis Protective Tape Precut (2)	Chassis Schutzfolie vorgeschritten (2) TLR 22-4	Protection adhésive de châssis prédécoupée (2)	TLR 22-4 nastro protettivo telaio, pretagliato (2)
TLR331012	Servo Mount, Aluminium: 22-4	Servo Halter Alu: 22-4	Support de servo en aluminium	Supporto servo, alluminio: 22-4
TLR331013	Skid Plate, Chassis (8): 22-4	Skid Plate, Chassis (8): 22-4	Patins de protection de châssis (8)	Piastra pattino, telaio (8): 22-4
TLR332010	Rear Hex, Std Width, Alum: 22-4	TLR 22-4: Radmutter hinten Std. Alu	Hexagone arrière, largeur std en aluminium	Esagoni posteriori, largh. std, alluminio: 22-4
TLR332011	Rear Hex, +1.5mm Width, Alum: 22-4	Radmutter hinten + 1,5mm Alu: 22-4	Hexagone arrière, largeur +1.5mm en aluminium	Esagoni posteriori, largh. 1,5mm, alluminio: 22-4
TLR334006	Sway Bar Kit, Front & Rear: 22-4	Querstabset v +h: 22-4	Kit de barres anti-roulis av et arr	Kit barra oscillante, anter. & poster.: 22-4
TLR334007	Front Spindle Set, Aluminium: 22-4	Front Spindel Alu: 22-4	Set de fusées avant en aluminium	Set fuso anter., alluminio: 22-4
TLR334008	Rear Hub Set, Aluminium: 22-4	Radträger hinten: 22-4	Set de fusées arrière en aluminium	Set mozzo posteriore, alluminio: 22-4
TLR334009	Steering Bellcrank Set, Aluminium: 22-4	Lenkhebel Set Alu: 22-4	Set de renvois de direction en aluminium	Set squadrette sterzo, alluminio: 22-4
TLR334010	Servo Horn, 23T, Aluminium: 22-4	Servo Horn, 23T, Alu: TLR 22-4	Bras de servo en aluminium, 23T	Squadretta servo, 23T, alluminio: 22-4
TLR334011	Servo Horn, 24T, Aluminium: 22-4	Servo Horn, 24T, Alu: TLR 22-4	Bras de servo en aluminium, 24T	Squadretta servo, 24T, alluminio: 22-4

Part #	English	Deutsch	Français	Italiano
TLR334012	Servo Horn, 25T, Aluminum: 22-4	Servo Horn, 25T, Alu: TLR 22-4	Bras de servo en aluminium, 25T	Squadretta servo, 25T, alluminio: 22-4
TLR334013	HD Turnbuckle Set, Titanium: 22-4	Gewindestangenset Titan: 22-4	Set de biellettes en titane	HD set tenditori, titanio: 22-4
TLR4166	Titanium Shock Mounts (4): 22	TLR Titan Dämpferbefestigung (4): 22	Fixations d'amortisseurs en titane	Supporti ammortizzatori in titanio (4): 22
TLR5099	Shock Tool Kit, Aluminum: 12mm Shock	TLR Dämpfer Werkzeugset, Aluminium: 12mm Dämpfer	Set d'outillage pour amortisseurs 12mm	Kit attrezzi ammortizz. 12mm, alluminio
TLR6030	Titanium Ball Stud, 4.8 x 6mm (2)	TLR Titan Kugelköpfe, 4.8 x 6mm (2)	Rotule en titane, 4,8 x 6mm (2)	Perno sferico, titanio, 4.8 x 6mm (2)
TLR6031	Titanium Ball Stud, 4.8 x 8mm (2)	TLR Titan Kugelköpfe, 4.8 x 8mm (2)	Rotule en titane, 4,8 x 8mm (2)	Perno sferico, titanio, 4.8 x 8mm (2)
TLR6032	Titanium Ball Stud, 4.8 x 10mm (2)	TLR Titan Kugelköpfe, 4.8 x 10mm (2)	Rotule en titane, 4,8x10mm (2)	Perno sferico, titanio, 4.8 x 10mm (2)
TLR72002	Slipper & Clicker Adjustment Tool: 22-4	TLR 22-4: Rutschkupplung Einstellwerkzeug	Outil de réglage de dureté de la roue libre et du slipper	Attrezzo regolazione slipper & clicker: 22-4
TLR74004	Silicone Shock oil, 25wt, 2oz	Silikonstoßdämpferöl, 25wt, 2 oz	Huile silicone d'amortisseur, 25wt, 60 ml	Olio silicone ammortizzatori, 25wt, 2oz
TLR74005	Silicone Shock oil, 27.5wt, 2oz	Silikonstoßdämpferöl, 27,5wt, 2 oz	Huile silicone d'amortisseur, 27,5wt, 60 ml	Olio silicone ammortizzatori, 27.5wt, 2oz
TLR74006	Silicone Shock Oil, 30wt, 2oz	Losi Silikonstoßdämpferöl, 30wt, 2oz	Huile silicone d'amortisseur, 30wt, 60 ml	Olio silicone ammortizz., 30wt, 2oz
TLR74007	Silicone Shock oil, 32.5wt, 2oz	Silikonstoßdämpferöl, 32.5wt, 2 oz	Huile silicone d'amortisseur, 32,5wt, 60 ml	Olio silicone ammortizzatori, 32.5wt, 2oz
TLR74008	Silicone Shock oil, 35wt, 2oz	Silikonstoßdämpferöl, 35wt, 2 oz	Huile silicone d'amortisseur, 35wt, 60 ml	Olio silicone ammortizzatori, 35wt, 2oz
TLR74019	Shock Oil 6Pk, 17.5, 22.5, 27.5, 32.5, 37.5, 42.5 2oz	Stoßdämpferöl 6 Set, 17.5, 22.5, 27.5, 32.5, 37.5, 42.5, 2oz	Assortiment de 6 flacons d'huile silicone d'amortisseur 17.5, 22.5, 27.5, 32.5, 37.5, 42.5 en 60ml	Olio ammortizzatori 6Pk, 17.5, 22.5, 27.5, 32.5, 37.5, 42.5 2oz
TLR74020	Shock Oil 6Pk, 20, 25, 30, 35, 40, 45, 2oz	Stoßdämpferöl 6 Set 6Pk, 20, 25, 30, 35, 40, 45, 2oz	Assortiment de 6 flacons d'huile silicone d'amortisseur 20, 25, 30, 35, 40, 45 en 60ml	Olio ammortizzatori 6Pk, 20, 25, 30, 35, 40, 45, 2oz
TLR8300	TLR Sticker Sheet	TLR Dekorbogen	Planche déco TLR	Foglio adesivi TLR
TLR99004	TLR Embroidered Cargo Bag	TLR Tasche	Sac de transport TLR	Borsa ricamata TLR
TLR99014	TLR Foam Pit Mat	TLR Schrauberplatte Schaum	Tapis de stand en mousse TLR	Stuoia gommapiuma TLR
TLR99101	Shock Shaft Pliers	TLR Zange für Dämpferkolbenstange	Pince à tige d'amortisseur	Pinze albero ammortizzatore
TLR99102	Turnbuckle Wrench, 22, 8ight, XXX	TLR Stellschlüssel für Gewindestift, 3.5, 4, 5mm	Clé à biellettes 3.5mm, 4mm, 5mm	Chiave per tenditore, 22, 8ight, XXX